

Seramik Elyaf Ürünler

LAVOBA İÇİN CNC VE MANUAL LAVA OBO DELME MAKİNESİ

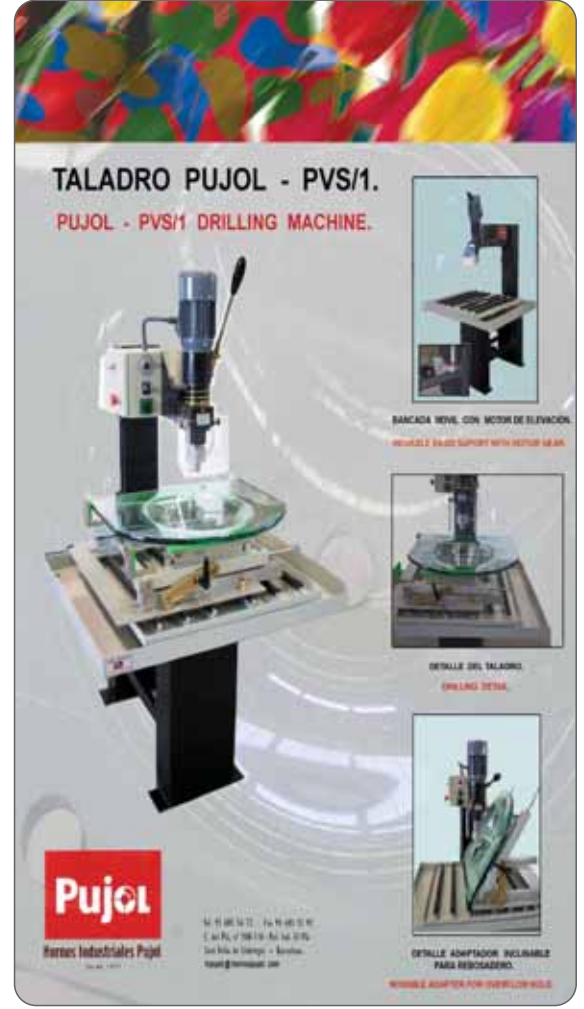

RODAJ MAKİNESİ

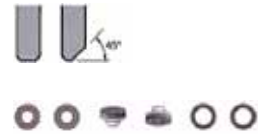

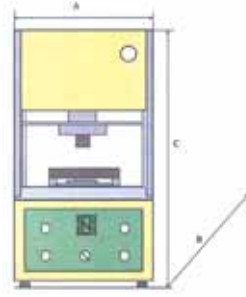

HYDRAULIC LABORATORY PRESS Mod. MIGNON S and MIGNON SS

TECHNICAL CHARACTERISTICS										
Mod.	A	B	C	Motor power kW	V. +N	Hz	Capacity ton.	Piston Ø mm.	Bar max.	Weight kg.
Mignon S	425	490	850	1,5	400	50/60	20	150	120	150
Mignon SS	510	710	910	2,5	400	50/60	40	150	230	240



POROSIMETER Series P

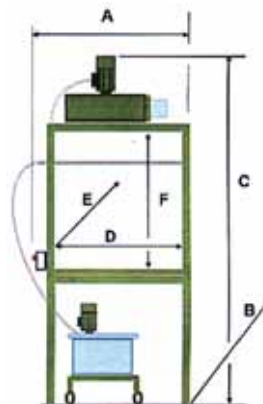

SPRAY CABIN Mod. F / 80 With Water Veil

TECHNICAL CHARACTERISTICS									
Mod.	A	B	C	D	E	F	V.	Hz	Weight kg.
F 80	950	950	2020	800	850	900	400	50/60	80

Laboratuar Ekipmanları



HYDRAULIC PRESS Mod. P 2500

CARATTERISTICHE TECNICHE										
Mod.	A	B	C	Motore kW	V.	Hz	Potenza ton.	Pistone Ø mm.	Bar max.	Peso Kg.
P 2500	1500	1500	2350	11	400	50/60	250	320	315	3800

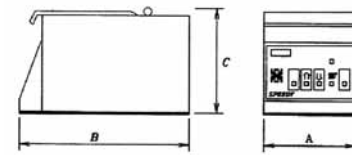

LABORATORY FAST MILL Mod SPEEDY

TECHNICAL CHARACTERISTICS						
A	B	C	Power kW	V. +N	Hz	Weight kg.
350	720	360	0,30	400	50/60	62



ELECTRICAL ROLLER KILN Series ER

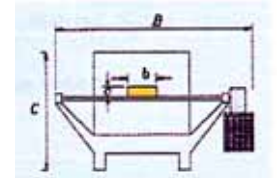

TECHNICAL CHARACTERISTICS														
Mod.	Temp. max.	a	b	c	A	B	C	KW	Ø Roller mm.	Distance roller mm.	V. +N	Controlled zones	Visualized zones	Weight kg.
ER 15	1320°C.	1585	180	40	2320	1090	1525	9	20	38,1	400	3	4	330
ER 20		2200	250	40	3330	1090	1525	16	20	38,1	400	4	6	350
ER 30		3600	380	40	5010	1170	1525	32	20	38,1	400	6	7	900
ER 60		6520	500	40	7930	1450	1400	52	20	38,1	400	10	10	2300

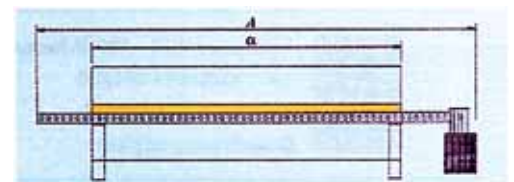

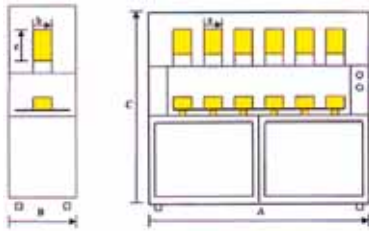
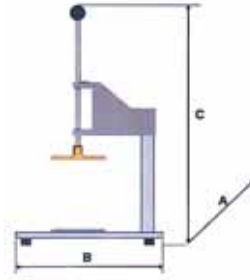

**GRADIGENT KILN,
Model GR / 98 and GR / 98 S**

TECHNICAL CHARACTERISTICS										
Mod.	Temp. max.	a	b	c	A	B	C	Power kW	V. +N	Weight kg.
GR 98	1320°C.	160	160	110	1570	480	1950	14,5	400	450
GR 98/S	1600°C.	160	160	110	1700	650	2000	18	400	580

PFEFFERKORN PLASTICIMETER

TECHNICAL CHARACTERISTICS			
A	B mm.	C	Weight kg.
250	370	480	24

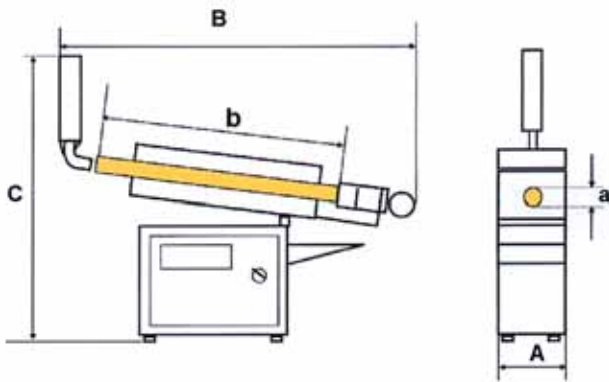

ROTARY TUBULAR LABORATORY KILN



TECHNICAL CHARACTERISTICS									
Mod.	Temp. max.	a Ø mm	b mm.	A	B mm.	C	Power kW	V.	Weight kg.
TO/R	1380°C.	60	1200	520	1580	1415	3	230	210
TO/RS	1550°C.	60	1200	520	1980	1415	4	230	220

Seramik Elyaf Ürünler

